

HOMEPOP

a Kinfine brand

Style Number :N8264

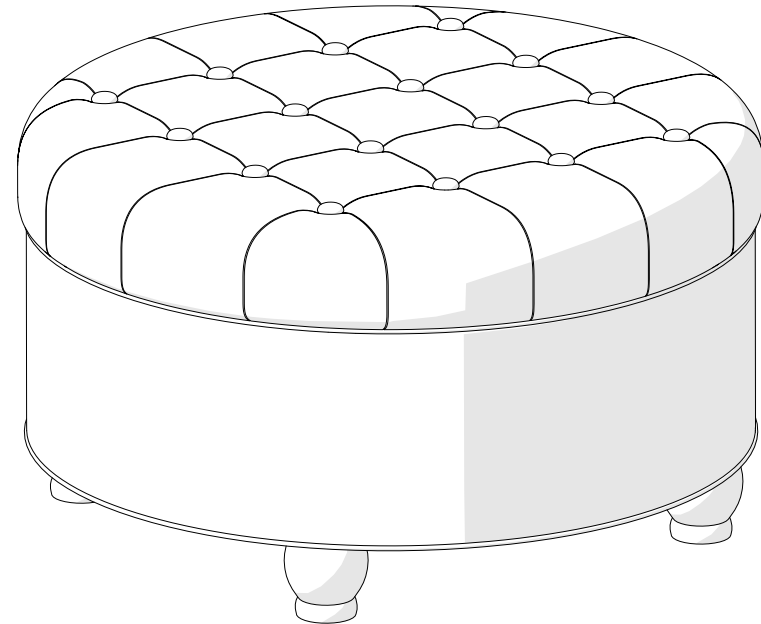

>>assembly instructions

Congratulations on your latest HomePop purchase.

Now what? Don't start sweating over this box of parts. This will be easy. We did the hard work for you. All you need to do is follow our simple instructions and you'll be on your way to transforming your room in no time. Good luck --though we're confident you won't need it.

before you begin

1. Check for damaged or missing parts. Customers can email service@kinfine.com or call 1-888-626-0888 to order missing supplies.
2. Use the carton as a working surface to prevent product damage during assembly.
3. Gather all tools prior to assembly.

table of contents



introduction	2
hardware	4
parts list	5
assembly	6-7

hardware

(A) x 4

5/16" x 3 1/8"
round hex screw

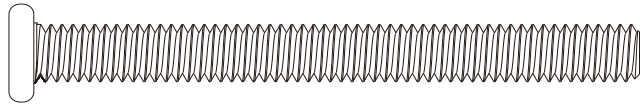
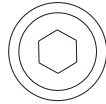

(B) x 4

5/8" flat washer

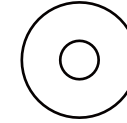

(C) x 1

1/4" Ball end
Hex wrench

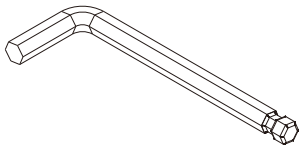

(D) x 4

ϕ 1 1/8" x 1/8"
Self adhesive foot pad



ITEM DESCRIPTION QUANTITY



①	cover	1
②	box	1
③	leg	4

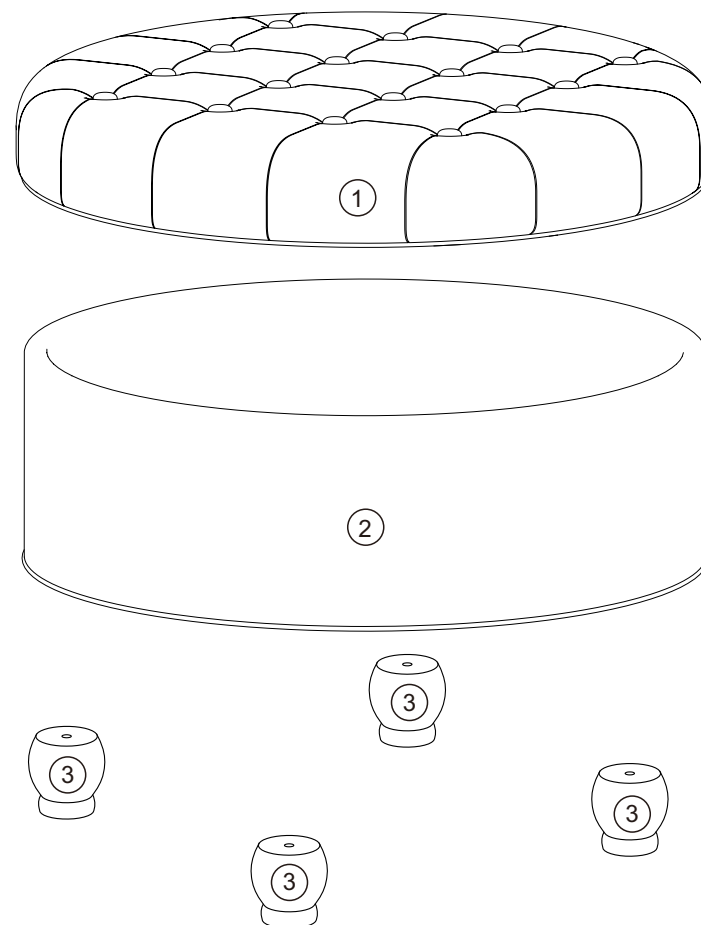

step 1.

1

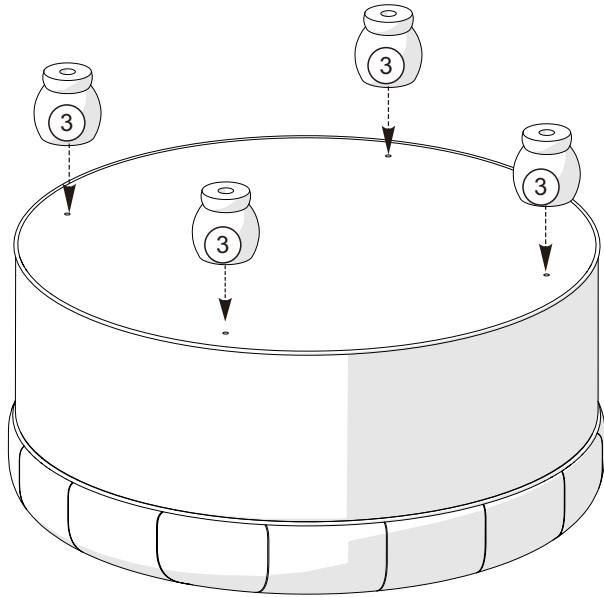

2

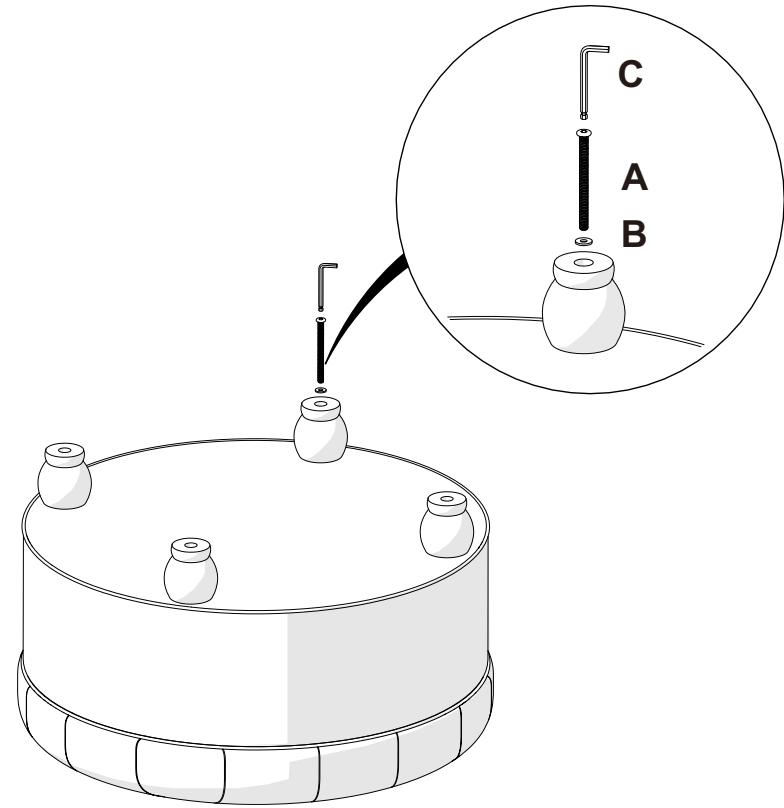

(A) x 4

5/16" x 3 1/8"
round hex screw

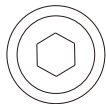
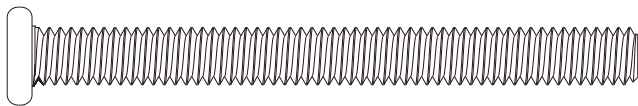

(B) x 4

5/8" flat washer

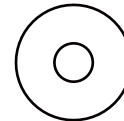

(C) x 1

1/4" Ball end
Hex wrench

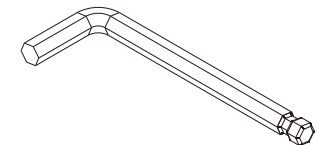

step 2.

1

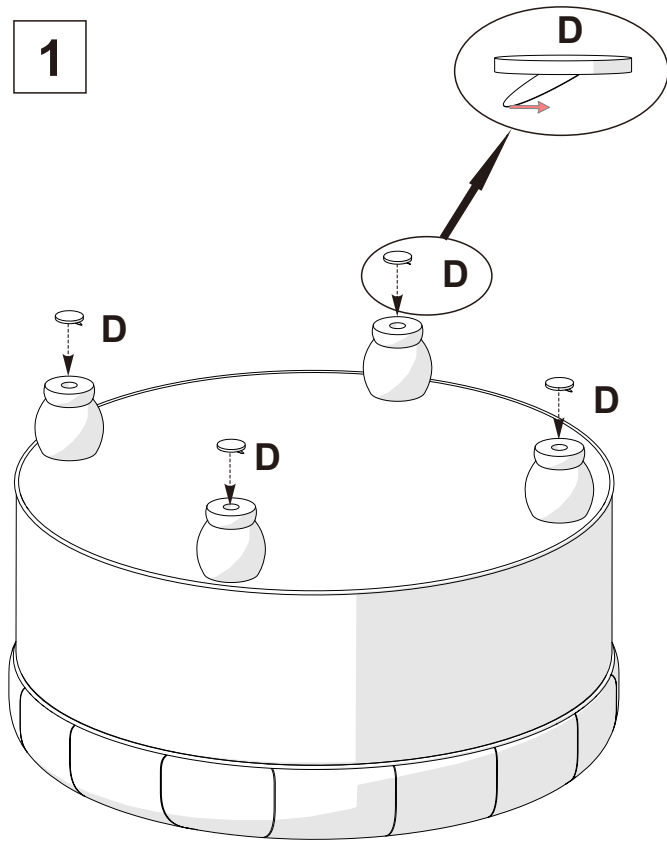

2

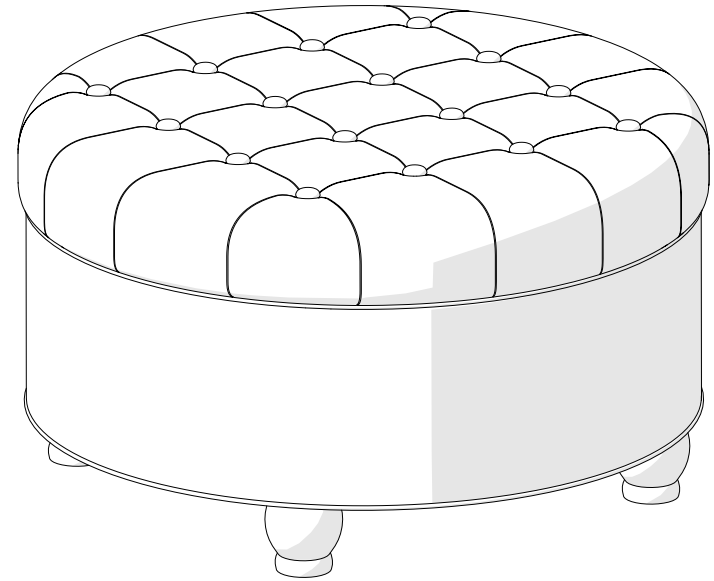

(D) x 4

ϕ 1 1/8" x 1/8"
Self adhesive foot pad

